

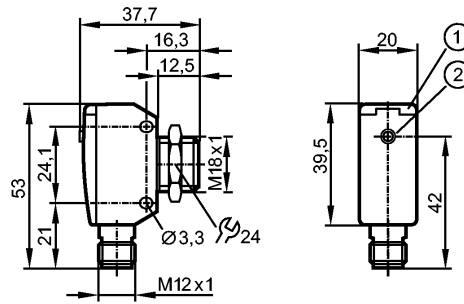

UGT586

UGQ00300F1KG/US

Ultrasonic sensors



- 1: LEDs
- 2: teach button



Product characteristics

Ultrasonic diffuse-reflection sensor

Cube

Quick disconnect

Teach function

Electrical data

Electrical design	DC NPN
Operating voltage [V]	10...30 DC; cULus - Class 2 source required
Current consumption [mA]	< 35
Protection class	III
Reverse polarity protection	yes
Power-on delay time [s]	0.1
Converter frequency [kHz]	300

Inputs

Teach	yes
-------	-----

Outputs

Output function	1 x NO / NC programmable + 1 x analog current
Current rating [mA]	100
Voltage drop [V]	2.2
Short-circuit protection	yes
Overload protection	yes
Analog output	
current output [mA]	4...20
Max. load [Ω]	500
Switching frequency [Hz]	8

Monitoring range

Sensing range [mm]	300
blind zone [mm]	40



UGT586

UGQ00300F1KG/US

Ultrasonic sensors

Response curve

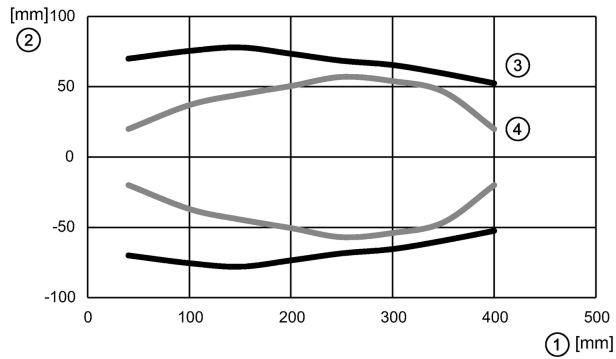

1: Distance; 2: Sound beam; 3: Target 100 x 100 mm; 4: Target Ø 25 mm

Angle of aperture	[°]	± 7
Max. deviation from the 90° angle sensor / object	[°]	± 4

Accuracy / deviations

Notes on the accuracy / deviation	The indicated values are reached after a warm-up time of ≥ 20 minutes	
Temperature compensation		yes
Hysteresis	[%]	< 1
Switch-point drift	[%]	± 2
Linearity error	[%]	≤ 1
Resolution	[mm]	3
Repeatability	[%]	< 0.7

Environment

Ambient temperature	[°C]	-20...70
Protection		IP 67

Tests / approvals

EMC	EN 61000-4-2 ESD:	4 kV CD / plastics 8 kV AD / metal
	EN 61000-4-3 HF radiated:	3 V/m
	EN 61000-4-4 Burst:	2 kV
	EN 61000-4-6 HF conducted:	3 V
	EN 55011:	class A
MTTF	[Years]	210
Vibration resistance		(10-55) Hz 1 mm amplitude, vibration duration 5 min., 30 min. per axis with resonance or 55 Hz
	EN 60068-2-6 Fc	
Shock resistance	EN 60068-2-27 Ea	yes

Mechanical data

Housing materials		1.4542; PBT; polyamide; Epoxid-Glaskeramik
Weight	[kg]	0.095

Displays / operating elements

Display		Switching status 1 LED yellow Echo LED 1 LED green
---------	--	---

Electrical connection

Connection		M12 connector
------------	--	---------------

Wiring



UGT586

UGQ00300F1KG/US

Ultrasonic sensors

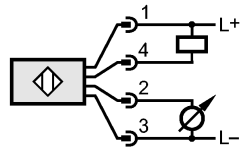

Accessories

Accessories (included)	1 stainless steel lock nut
------------------------	----------------------------

Remarks

Remarks	cULus - Class 2 source required
---------	---------------------------------

Pack quantity	[piece]	1
---------------	---------	---