

TN2115

TN-050KLBM14-MFRKG/US/

Temperature sensors

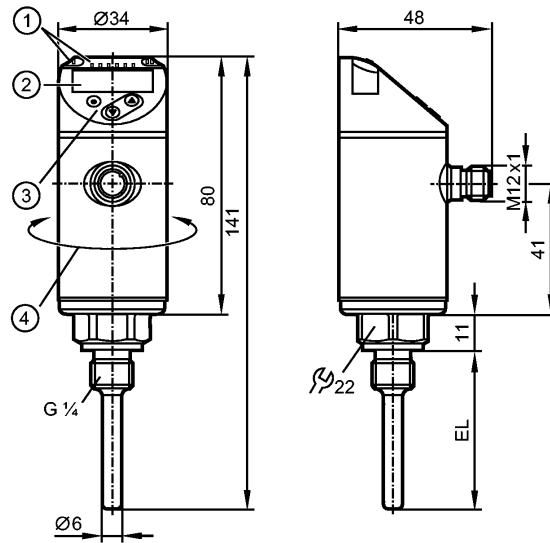

- 1: LEDs (display unit / switching status)
- 2: 4-digit alphanumeric display / alternating indication of red and green
- 3: Programming buttons
- 4: Upper part of the housing can be rotated by 345°



Product characteristics

Electronic temperature sensor
Process connection: G 1/4
Installation length EL: 50 mm
2 outputs OUT1 = switching output OUT2 = switching output or analog output
4-digit alphanumeric display
Measuring range: -50...150 °C / -58...302 °F
Measuring element: 1 x Pt 1000, to DIN EN 60751, class A
Factory setting: -50...150 °C

Application

Application	liquids and gases
Pressure rating [bar]	400

Electrical data

Electrical design	DC PNP/NPN
Operating voltage [V]	18...32 DC; cULus - Class 2 source required
Current consumption [mA]	< 50
Protection class	III
Reverse polarity protection	yes

Outputs

Output	2 outputs OUT1 = switching output OUT2 = switching output or analog output
Output function	2 x normally open / closed programmable or 1 x normally open / closed programmable + 1 x analogue (4...20 mA / 0...10 V)
Current rating [mA]	250
Voltage drop [V]	< 2.5



TN2115

TN-050KLBM14-MFRKG/US/

Temperature sensors

Short-circuit protection		yes (non-latching)
Overload protection		yes
Max. load	[Ω]	4...20 mA: 500
Min. load	[Ω]	0...10 V: 2000

Measuring / setting range		
Measuring range	-50...150 °C	-58...302 °F
Factory setting	-50...150 °C	
Setting range		
Set point, SP	-49.8...150 °C	-57.6...302 °F
Reset point, rP	-50...149.8 °C	-58...301.6 °F
Analog start point, ASP	-50...145 °C	-58...293 °F
Analog end point, AEP	-45...150 °C	-49...302 °F
in steps of	0.1 °C	0.1 °F
Resolution		
Switching output	[K]	0.1
Analog output	[K]	MS / 4096 *) MS / 3561 **)
Display	[K]	0.1

Accuracy / deviations		
Switch point accuracy	[K]	± 0.3 + (± 0.1 % MS)
Analog output	[K]	± 0.3 + (± 0.1 % MS)
Display	[K]	± 0.3 + (± 0.1 % MS)
Temperature coefficients (in % of the span per 10 K)		0.1

Reaction times		
Power-on delay time	[s]	1
Dynamic response	T05 / T09 [s]	1 / 3 ***)
Integrated watchdog		yes

Software / programming	
Programming options	hysteresis / window function; NO / NC; output polarity; on delay, off delay; damping; display unit; current / voltage output

Interfaces	
IO-Link Device	
Transfer type	COM2 (38.4 kBaud)
IO-Link revision	1.1

Environment		
Ambient temperature	[°C]	-25...80
Storage temperature	[°C]	-40...100
Protection		IP 67

Tests / approvals		
EMC		DIN EN 61000-6-2 DIN EN 61000-6-3
Shock resistance		DIN IEC 68-2-27: 50 g (11 ms)
Vibration resistance		DIN EN 60068-2-6 20 g (10...2000 Hz)
MTTF	[Years]	207
UL approval number		K015

Mechanical data		
-----------------	--	--

TN2115

TN-050KLBM14-MFRKG/US/

Temperature sensors

Process connection	G 1/4
Materials (wetted parts)	stainless steel (316L / 1.4404); O-ring: FKM
Installation length EL [mm]	50
Housing materials	stainless steel (316L / 1.4404); PBT+PC-GF 30; PBT-GF 20; PC
Weight [kg]	0.208

Displays / operating elements

Display	Display unit 2 x LED green Switching status 2 x LED yellow 4-digit alphanumeric display / alternating indication Measured values of red and green
---------	--

Electrical connection

Connection	M12 connector; gold-plated contacts
------------	-------------------------------------

Wiring

- Core colors
- BK black
 - BN brown
 - BU blue
 - WH white

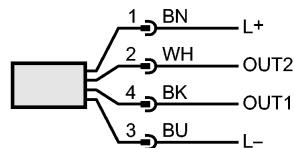

OUT1: switching output or IO-Link
 OUT2: switching output or 4...20 mA / 0...10 V
 Colours to DIN EN 60947-5-2

Remarks

Remarks	*) current output **) voltage output ***) according to DIN EN 60751 MS = set measuring span The values for accuracy apply to flowing water.
---------	---

Pack quantity [piece]	1
-----------------------	---