

OY109S

OYA1360-90-4-12-P-1

Photoelectric sensors

Please note the wiring of the sensor and the sockets (see data sheet) as for 8-pole sockets the core colours are not standardised.

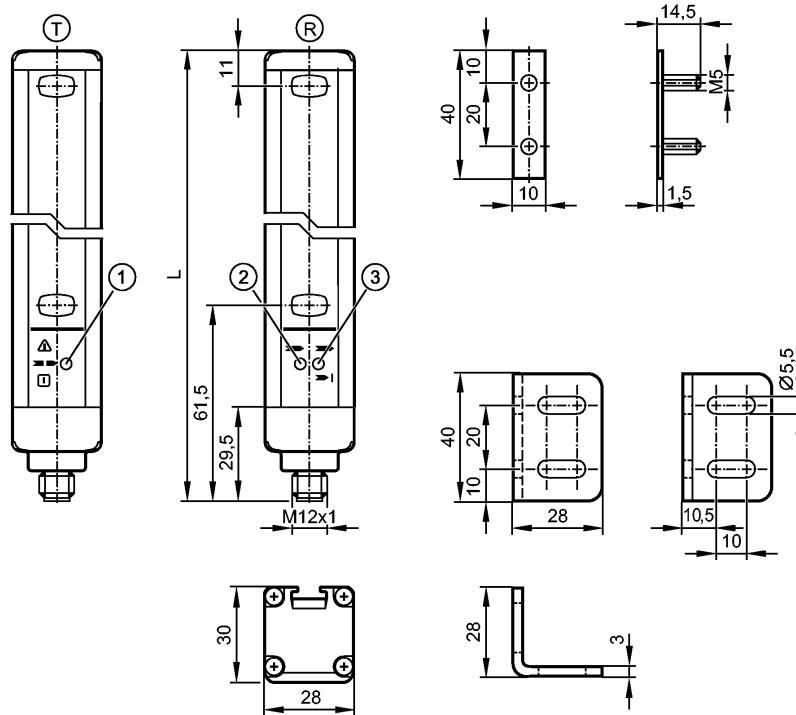

- T: Transmitter
- R: Receiver
- 1: LED 3 colours (red/green/orange)
- 2: LED (yellow)
- 3: LED 2 colours (red/green)



Product characteristics

Safety light curtain	
Length L: 1413 mm	
Quick disconnect	
Complies with the requirements:	
type 4 (IEC 61496-1)	
SIL 3 (IEC 61508)	
SILcl 3 (IEC 62061)	
PL e (EN ISO 13849-1)	

Electrical data

Electrical design		DC PNP
Operating voltage	[V]	24 DC (19.2...28.8)
Current consumption		
- Transmitter	[mA]	42
- Receiver	[mA]	83
Type of light		Infrared light 950 nm
Protection class		III
Reverse polarity protection		yes
Power-on delay time	[s]	< 2

Outputs

OY109S

OYA1360-90-4-12-P-1

Photoelectric sensors

Outputs (OSSDs)	2 x PNP
Max. current load per output [mA]	400 (24 V)
Short-circuit protection	yes

Monitoring range	
Protected area height [mm]	1360
Resolution (detection capacity d)[mm]	90
Protected area width (range) [m]	0...4 / 3...12

Reaction times	
Response time [ms]	6

Environment	
Applications	Class C to EN 60654-1 weatherproof application
Ambient temperature [°C]	-10...55
Storage temperature [°C]	-20...70
Max. relative air humidity [%]	95
Protection	IP 65 / IP 67

Tests / approvals	
EMC	IEC 61496-1
Shock resistance	IEC 61496-1
Vibration resistance	IEC 61496-1

Safety classification	
Mission time TM [h]	175200
Test interval T1 [Years]	20
Safety-related reliability PFHd [1/h]	1.0E-08
MTTFd [Years]	100
DC/CCF/Cat.	97.05% / 80 % / 4

Mechanical data	
Length L [mm]	1413
Housing materials	housing: aluminum; window: PC
Weight [kg]	4.654

Displays / operating elements	
Display	Transmitter 1 LED Receiver 2 LED

Electrical connection	
Transmitter	
Connection	M12 connector

Wiring Transmitter

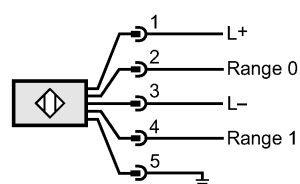
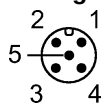

Receiver	
Connection	M12 connector

Wiring Receiver

OY109S

OYA1360-90-4-12-P-1

Photoelectric sensors

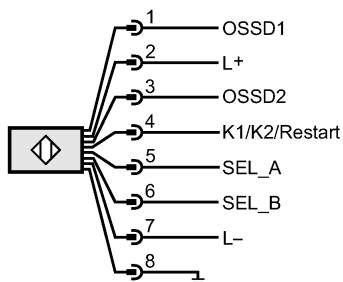
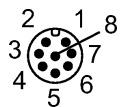

Max. connection cable length [m]	100 *)
----------------------------------	--------

Accessories

Accessories (included)	6 Assembly angle; 6 Mounting Nuts; nuts
------------------------	---

Remarks

Remarks	*) for wire cross-section 0.34 mm ²
---------	--

Pack quantity [piece]	1
-----------------------	---

ifm efector, inc. • 1100 Atwater Drive • Malvern • PA 19355 — We reserve the right to make technical alterations without prior notice. — US — OY109S — 24.03.2009

Please note the wiring of the sensor and the sockets (see data sheet) as for 8-pole sockets the core colours are not standardised.