

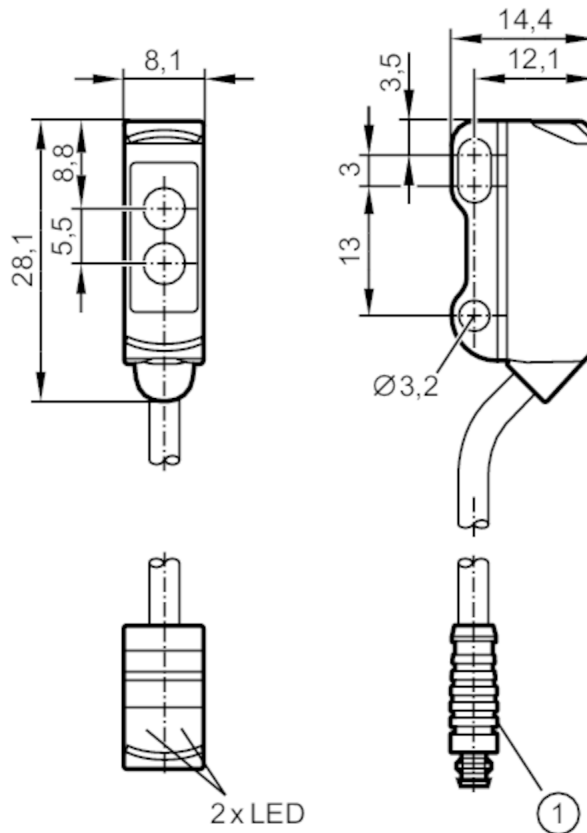

Diffuse reflection sensors with background suppression

O8H-FPKG/IO-Link/0,30M/AS/3P



1: illustration (example)
Receiver in upper lens
transmitter in lower lens



Product characteristics	
Type of light	red light
Housing	rectangular
Application	
System	Background suppression
Function principle	Diffuse reflection sensor
Electrical data	
Operating voltage [V]	10...30 DC
Current consumption [mA]	20; ((24 V))
Protection class	III
Reverse polarity protection	yes
Type of light	red light
Wave length [nm]	633



Diffuse reflection sensors with background suppression

O8H-FPKG/IO-Link/0,30M/AS/3P

Outputs		
Electrical design	PNP	
Output function	light-on/dark-on mode; (programmable)	
Max. voltage drop switching output DC [V]	2.5	
Permanent current rating of switching output DC [mA]	100	
Switching frequency DC [Hz]	1000	
Short-circuit protection	yes	
Type of short-circuit protection	yes (non-latching)	
Monitoring range		
Range [mm]	1...30; (white paper 200 x 200 mm)	
Range on white object (90 % remission) [mm]	1...30	
Range on grey object (18 % remission) [mm]	5...30	
Range on black object (6 % remission) [mm]	5...29	
Range adjustable	yes	
Max. light spot diameter [mm]	4	
Light spot dimensions refer to	at maximum range	
Monitoring range final value [mm]	10...80	
Background suppression available	yes	
Interfaces		
Communication interface	IO-Link	
Transmission type	COM2 (38,4 kBaud)	
IO-Link revision	1.1	
SDCI standard	IEC 61131-9	
Profiles	Smart Sensor: Device Identification; Device Diagnosis; Teach Channel; Switching Channel	
SIO mode	yes	
Required master port class	A	
Min. process cycle time [ms]	3	
IO-Link process data (cyclical)	Function	bit length
	process value	8
	device status	4
IO-Link functions (acyclical)	binary switching information	1
	application specific tag; operating hours counter; switching cycles counter	
Supported DeviceIDs	Type of operation	DeviceID
	default	535
Operating conditions		
Ambient temperature [°C]	-25...60	
Protection	IP 65; IP 67	



Diffuse reflection sensors with background suppression

O8H-FPKG/IO-Link/0,30M/AS/3P

Tests / approvals		
EMC		EN 60947-5-2
MTTF	[years]	757
UL approval	Ta	-25...60 °C
	Enclosure type	Type 1
	voltage supply	Limited Voltage/Current
	UL approval number	E017
	File number UL	E174191

Mechanical data		
Weight	[g]	20.9
Housing		rectangular
Dimensions	[mm]	28.1 x 8.1 x 14.4
Material		housing: ABS; stainless steel (1.4404 / 316L)
Lens material		PMMA
Lens alignment		Side sensing

Displays / operating elements		
Display	Switching status	1 x LED, yellow
	Power	1 x LED, green

Remarks	
Pack quantity	1 pcs.

Electrical connection

Cable: 0.3 m, PVC; 3 x 0.08 mm²

Connector: 1 x M8; coding: A



Connection

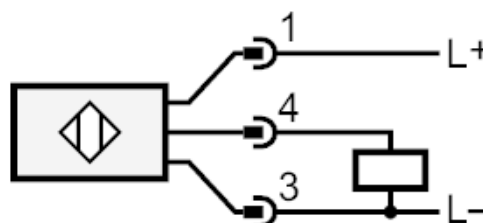



Diffuse reflection sensors with background suppression

O8H-FPKG/IO-Link/0,30M/AS/3P

Diagrams and graphs

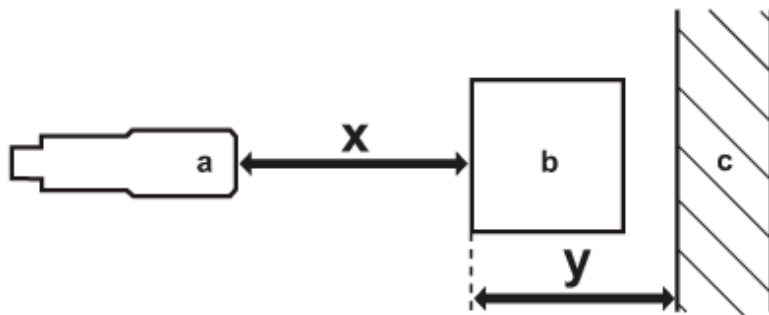

- a: sensor
- b: object
- c: background
- x: distance sensor/object [mm]
- y: min. distance object/background [mm]

Background suppression chart

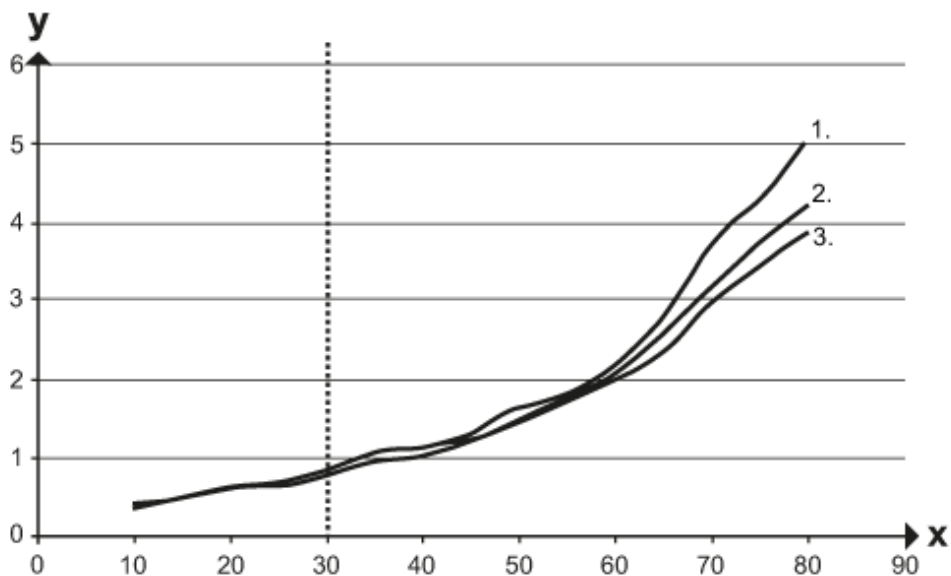

- x: distance sensor/object [mm]
- y: min. distance object/background [mm]
- 1 = object black (6 % remission) , background (white 90 % remission)
- 2 = object grey (18 % remission) , background (white 90 % remission)
- 3 = object white (90 % remission) , background (white 90 % remission)