

EVF537

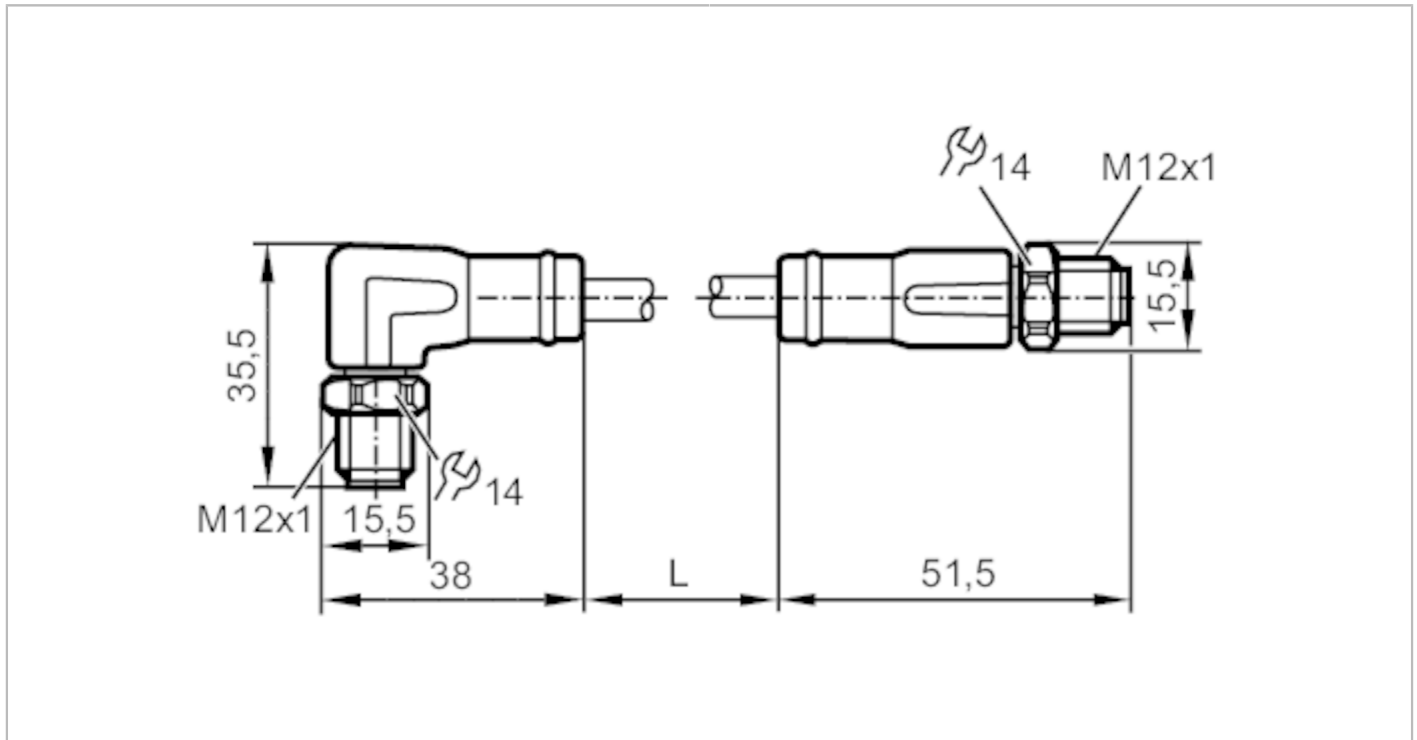

Ethernet connection cable

VSTGN040VAS0001P04STAN040VAS



Application	
System	Free from silicone; Halogen-free; gold-plated contacts; screened cable; Drag chain suitability
Design	Ethernet cable, D-coded
Application	Industrial Ethernet; CAT5/CAT5e; 100 Mbit/s; sanitary and wet areas in the food industry
Free from silicone	yes
Electrical data	
Operating voltage [V]	30 AC / 60 DC
Protection class	III
Max. current load total [A]	4
Operating conditions	
Ambient temperature [°C]	-25...100
Ambient temperature (moving) [°C]	0...80
Protection	IP 65; IP 67; IP 68; IP 69K

EVF537



Ethernet connection cable

VSTGN040VAS0001P04STAN040VAS

Mechanical data		
Weight [g]	101.4	
Material	PP Halogen-free	
Molded-body material	PP	
Material nut	stainless steel (1.4404 / 316L)	
Drag chain suitability	yes	
Drag chain suitability	Bending radius for flexible applications	min. 15 x cable diameter
	Travel speed	max. 3.3 m/s for a horizontal travel length of 5 m and max. acceleration of 5 m/s ²
	Bending cycles	> 1 Mio.
	Torsional strain	± 180 °/m

Remarks

Pack quantity	1 pcs.
---------------	--------

Electrical connection - Angled version

Connector: 1 x M12, angled; Moulded body: PP; Locking: stainless steel (1.4404 / 316L); Contacts: gold-plated; Tightening torque: 0.6...1.2 Nm; Shielded connection cable: shield connected



Electrical connection

Cable: 1 m, MPPE, Halogen-free, grey, Ø 6.5 mm, screened; PROFINET Type C; 4 x 0.34 mm² (7 x Ø 0.25 mm)

Connection

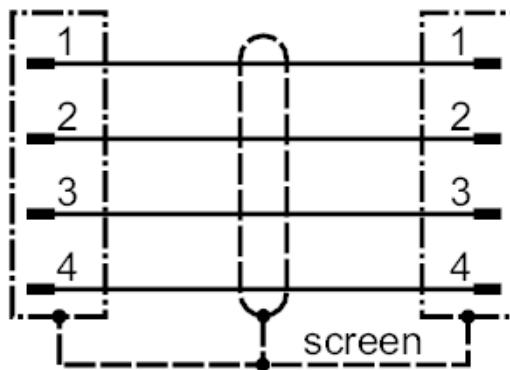

Electrical connection - Straight version

Connector: 1 x M12, straight; Moulded body: PP; Locking: stainless steel (1.4404 / 316L); Contacts: gold-plated; Tightening torque: 0.6...1.2 Nm; Shielded connection cable: shield connected

EVF537



Ethernet connection cable

VSTGN040VAS0001P04STAN040VAS

